

Mladen ZEC  
Robert P. UHLIG  
Marek ZIOLKOWSKI  
Hartmut BRAUER

## LORENTZ FORCE EDDY CURRENT TESTING: TWO-DIMENSIONAL NUMERICAL STUDY<sup>\*)</sup>

**ABSTRACT** *The main aim of this work is to provide 2D numerical data for the motion of a permanent magnet in the vicinity of a solid state body. The goals of this work include the evaluation of induced eddy current, total and current Lorentz Force (LF) distribution inside a solid body accounting for pre-defined defects. The approach of logical expressions and of a moving mesh were used successfully to solve the presented linear eddy current testing problem (LET). The logical expression approach, for the similar number of degrees of freedom, was able to solve the given problem approximately 8 times faster than the moving mesh approach.*

**Keywords:** *permanent magnet, eddy currents, Lorentz force, defects, defect detection, contactless testing, non-destructive testing*

---

<sup>\*)</sup> The presented work is supported by the Deutsche Forschungsgemeinschaft in the framework of the Research Training Group 1567 "Lorentz force velocimetry and Lorentz force eddy current testing".

---

**Mladen ZEC, Robert P. UHLIG  
Marek ZIOLKOWSKI, Hartmut BRAUER**

Department of Advanced Electromagnetics,  
Ilmenau University of Technology, Germany

---

## 1. INTRODUCTION

---

Lorentz force eddy current testing (LET) is a non-contact and non-destructive testing method used to detect deep material defects in solid, conducting materials. The basic working principle of LET is based on measurement of the Lorentz force (LF) produced due to the relative motion between a permanent magnet and the material under test. When the magnet is swept across the defect the LF acting on the magnet is temporarily changed. The detection of these LF perturbations enables the identification and localisation of any material defect. The main aim of this work is to provide 2D numerical data for the motion of a permanent magnet (PM) in the vicinity of a solid state body. The analysis is performed for a so called “linear LET” problem, considering a PM moving linearly above a solid bar (Fig. 1). The finite element method (FEM) based on the commercial solver COMSOL Multiphysics is used to simulate the real geometry of the given problem with appropriate governing differential equations. The goals of this work include the evaluation of induced eddy currents, total and local LF distribution inside a solid body accounting for pre-defined defects.

---

## 2. AIMS AND METHODS

---

Electromagnetic devices involving motion are commonly simulated using transient models. Transient finite element (FE) simulation techniques usually involve re-meshing the geometry, choosing an appropriate time solver and often results in excessive computation cost. If there is no anisotropy of the material properties in the movement direction and the movement does not change the spatial configuration of the model, these problems can be avoided using a quasistatic formulation (QS) [2, 3 and 4]. Similarly, the same QS formulation could be used if the finite diffusion time of the magnetic field is neglected (e.g. magnetic Reynolds number,  $R_m = \sigma \mu \nu H / 2 \ll 1$ ) [3, 4]. For typical applications involving LET, the magnetic Reynolds number is not negligible. Therefore for accurate modelling, the transient (TR) formulation has to be used. Nevertheless, the QS formulation is used to provide consistent initial conditions used in the TR simulations, thereby reducing the overall computing time.

For the numerical implementation of the TR formulation two different approaches are used, namely (i) logical expression (LE) and (ii) moving mesh (MM) approach. The LE has been successfully applied for the motion of a PM

above a solid bar in [3]. On the other hand, the moving mesh technique is widely used for modelling rotating electrical machines [7]. The common feature of both the models is the fact that remeshing of the computational domain is not necessary during the simulation.

The structure of the remainder of the paper is divided into three main parts. In the first part the LE and MM transient approaches are applied and compared for a 2D linear LET problem (Fig. 1). The main aim of this analysis is to provide the information regarding the computational requirements of the used approaches.

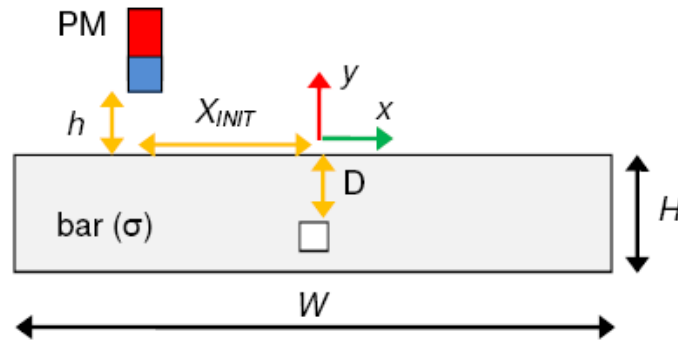

Fig. 1. Schematic diagram of the linear LET

The advantages and disadvantages of the applied methods are discussed as well. In the second part we study the influence of the applied initial conditions on the efficiency of the numerical simulations concerning LET applications. The initial conditions are provided through a coupling between the QS and TR formulations. The last part comprises some basic concepts of the LET technique accounting for the pre-defined defects. The numerical data resulting from the 2D parametric study, regarding the testing depth capabilities, testing velocity influence and defects size investigations are presented.

### 3. NUMERICAL MODEL

Due to relative movement between a conducting body (testing material) and the permanent magnet eddy currents are induced inside the material. The interaction between the imposed magnetic field ( $\mathbf{B}$ ) and induced eddy currents ( $\mathbf{J}$ ) results in a Lorentz force ( $\mathbf{f} = \mathbf{J} \times \mathbf{B}$ ) opposing the relative motion. Furthermore, an equal and opposite force in the movement direction acts on the

permanent magnet [2]. The presence of a defect in the material produces a temporary change in the eddy current distribution. These perturbations are detected through the Lorentz force acting on the magnet. In order to evaluate the resulting LF both the magnetic flux density and the induced eddy current density have to be determined.

Using the Maxwell's equations and some vector calculus identities, the following partial differential equation (PDE) describing the time changing magnetic field in the presence of moving conductors can be derived.

$$\frac{\partial \mathbf{B}}{\partial t} = \nabla \times (\mathbf{v} \times \mathbf{B}) + \frac{1}{\sigma \mu} \nabla^2 \mathbf{B} \quad (1)$$

Here  $\sigma$ ,  $\mu$  and  $v$  represent the electrical conductivity, magnetic permeability and velocity of the testing material, respectively. The result is a so-called magnetic field induction equation valid for both the PM and the testing specimen in motion [1]. It should be mentioned that instead of the PM any DC magnet system could be used for the practical realisation of the LET technique.

For the numerical implementation of the TR approaches we consider a PM to be in motion relative to a stationary body. With this assumption, the first term on the right hand side of the induction equation goes to zero ( $v = 0$ ) and the time derivative of the magnetic field is balanced by its diffusion:

$$\frac{\partial \mathbf{B}}{\partial t} = \frac{1}{\sigma \mu} \nabla^2 \mathbf{B} \quad (2)$$

If we neglect the finite diffusion time ( $\tau = H^2 \mu \sigma$ ) of the magnetic field, and thereby assume that the magnetic field reacts instantaneously to any perturbation caused by the defect, the time derivative on the left hand side of the induction can be neglected. In order to account for the motion of the solid body, the defect has to move accordingly [3]. The induction equation is then simplified to its static form:

$$0 = \nabla \times (\mathbf{v} \times \mathbf{B}) + \frac{1}{\sigma \mu} \nabla^2 \mathbf{B} \quad (3)$$

This represents a so-called QS formulation. It should be reiterated that this formulation is only accurate when there is no anisotropy of the material properties in the movement direction and the movement does not change the spatial configuration of the model.

## 4. RESULTS

### 4.1 Comparison between LE and MM approaches

The geometrical and material parameters used for the comparison of the considered LET problem are summarized in Table 1.

**TABLE 1**

Model geometry and material parameters

$W_{PM}$	$H_{PM}$	$W$	$H$	$h$	$\sigma$	$\mu$	$v$	$x_{INIT}$
10 mm	15 mm	250 mm	50 mm	3 mm	20.5 MS/m	$4 \cdot \pi \cdot 10^{-7}$ H/m	0.5 m/s	-170 mm

In order to compare the LE and MM transient approaches we consider a solid body without any defects. The comparison is performed through the integral values of LF components acting on the moving PM, namely drag force ( $F_D$ ) and lift force ( $F_L$ ). The starting position of the magnet ( $x_{INIT}$ ) is considered to be outside the bar to account for the bar edges.

From the obtained results good agreement between the LE and MM approach is observed (Fig. 2). Nevertheless, the LE approach was able to solve the given problem in much shorter time ( $\approx 8$  times faster) than the MM approach for approximately the same number of degrees of freedom (DoF).

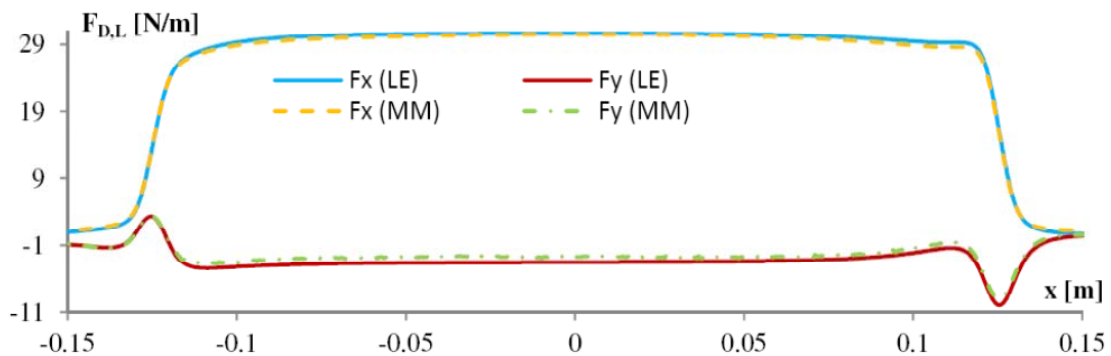

**Fig. 2. Comparison of LE and MM TR approaches for a linear LET problem**

In addition to the faster computing time the LE approach provides an easier and more efficient way of performing dynamic simulations involving large

displacements. The resulting structure of the stiffness matrix also enables the use of iterative solvers [5]. This is of great importance when a 3D numerical model, resulting in a large number of DoF, needs to be considered. The main disadvantages of the LE approach are its limitation to relatively simple magnet shapes and to a constant displacement velocity ( $v$ ). As a consequence the time solver with constant time step ( $\Delta t$ ) has to be used. If this is not the case the numerical oscillation of the solution due to the non-matching grids ( $\Delta x \neq v \cdot \Delta t$ ) is introduced. Some of these limitations can be avoided by more intuitive geometry modelling and meshing techniques [5].

#### 4.2 TR formulation using LE: with and without initial conditions

---

The main aim of the LET technique is the defect localization and reconstruction based on LF perturbations. These perturbations strongly depend on the shape of magnet, defect type and its location within the material ( $D$ ). Furthermore, the applied testing velocity ( $v$ ) also has a strong influence. Typically for such complicated dynamic problems the computational cost for the numerical simulations is quite high. Therefore, to reduce the computational time it is important to provide adequate initial conditions to the TR simulations.

For the TR simulations used in order to compare the applied approaches (LE and MM), the PM is initially considered to be outside the bar ( $x_{\text{INIT}}$ ). At this initial position, due to the absence of any conducting material in the vicinity of the moving magnet, the bar has no influence on the resulting magnetic field distribution. The field of the magnet is diffused through the air.

In order to study the LF perturbations only due to defects, the bar is considered to be long enough such that its length is infinite. At the initial position the magnet is placed above the bar in the close vicinity of the defect ( $x_{\text{INIT}}$ ). Nevertheless, the initial position has to be sufficiently far away from the defect in order to insure the converged values of LF. When the magnet is set in motion [ $v(t) = v \cdot h(t - t_0)$ ], due to the finite diffusion time of the magnetic field, large number of time steps are needed for the LF to converge. As a consequence the distance travelled by the magnet before LF equilibrium is reached increases (Fig. 4: a-d). It should be mentioned that the response time of the magnetic field increases with the applied velocity. To avoid this unnecessary computational expense, the authors propose the use of an initial QS solution, the resulting magnetic field  $\mathbf{B}$ , as input to the subsequent TR analysis (Fig. 3). This approach considerably shortens the distance travelled by the magnet before LF equilibrium ( $x_{\text{INIT}}$ ) is reached, Figure 3.

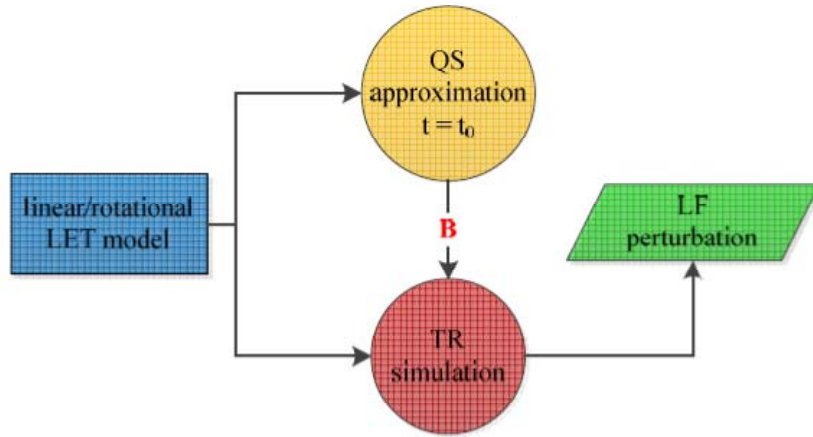

Fig. 3. Coupling between the TR and QS approach

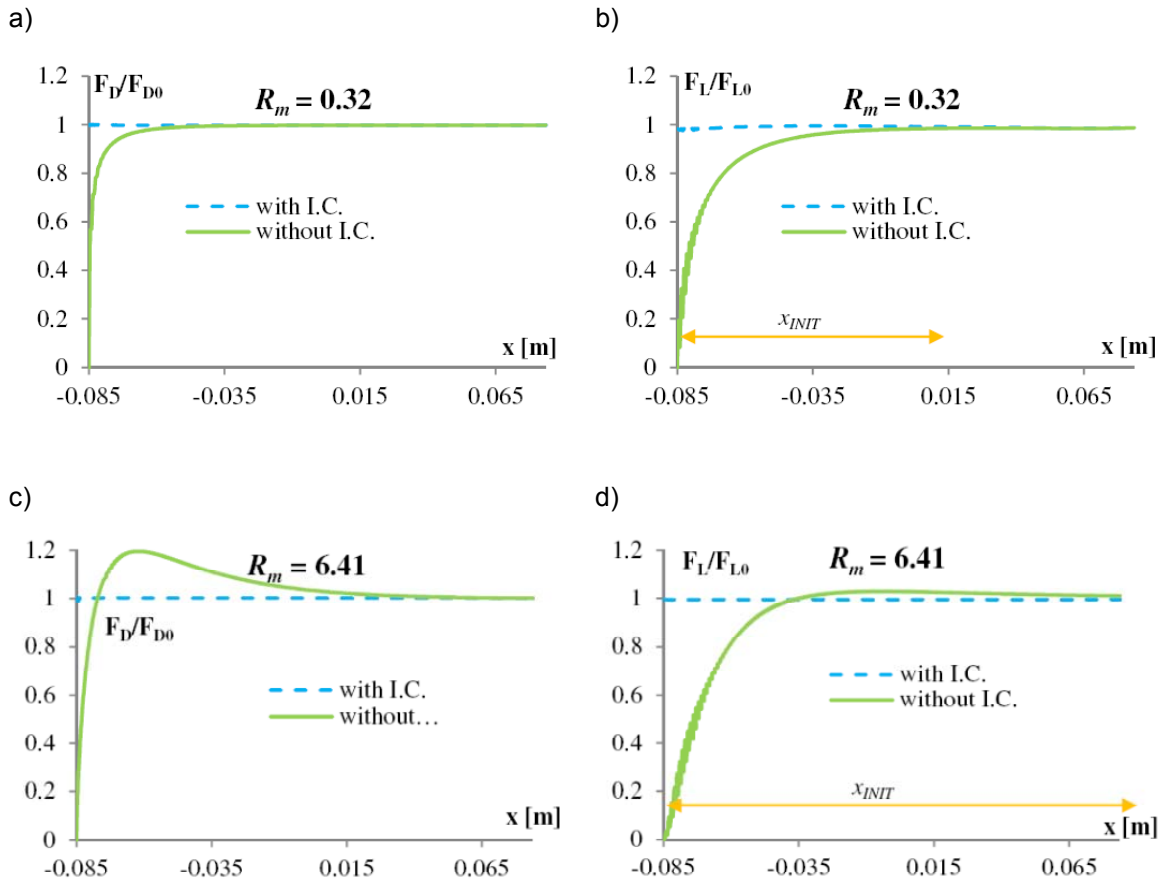

Fig. 4. LF evaluated using TR approach with and without applied initial conditions (I.C.),  $x_{INIT} = -85$  mm

At low  $R_m$ , the drag ( $F_D$ ) and lift ( $F_L$ ) components of LF are proportional to  $R_m$  and  $R_m^2$ , respectively [4]. As a result it takes longer for the lift component to converge (Fig. 4: a, b). At the higher values of magnetic Reynolds number

both LF components show similar convergence (Fig. 4: c, d) due to the decreased dependency on the  $R_m$  value [4].

From the obtained results it is evident that, providing the adequate initial conditions to the TR formulation, the initial distance of the magnet from the defect ( $x_{INIT}$ ) is considerably reduced.

### 4.3 Parametric study

Commercially available high-end force sensors (e.g. strain gauge load cells) have an accuracy of 0.1% of the force change [8]. Therefore, LF perturbations are numerically studied for various depths ( $D$ ) of the defect from the material surface to understand the testing capabilities of the LET technique.

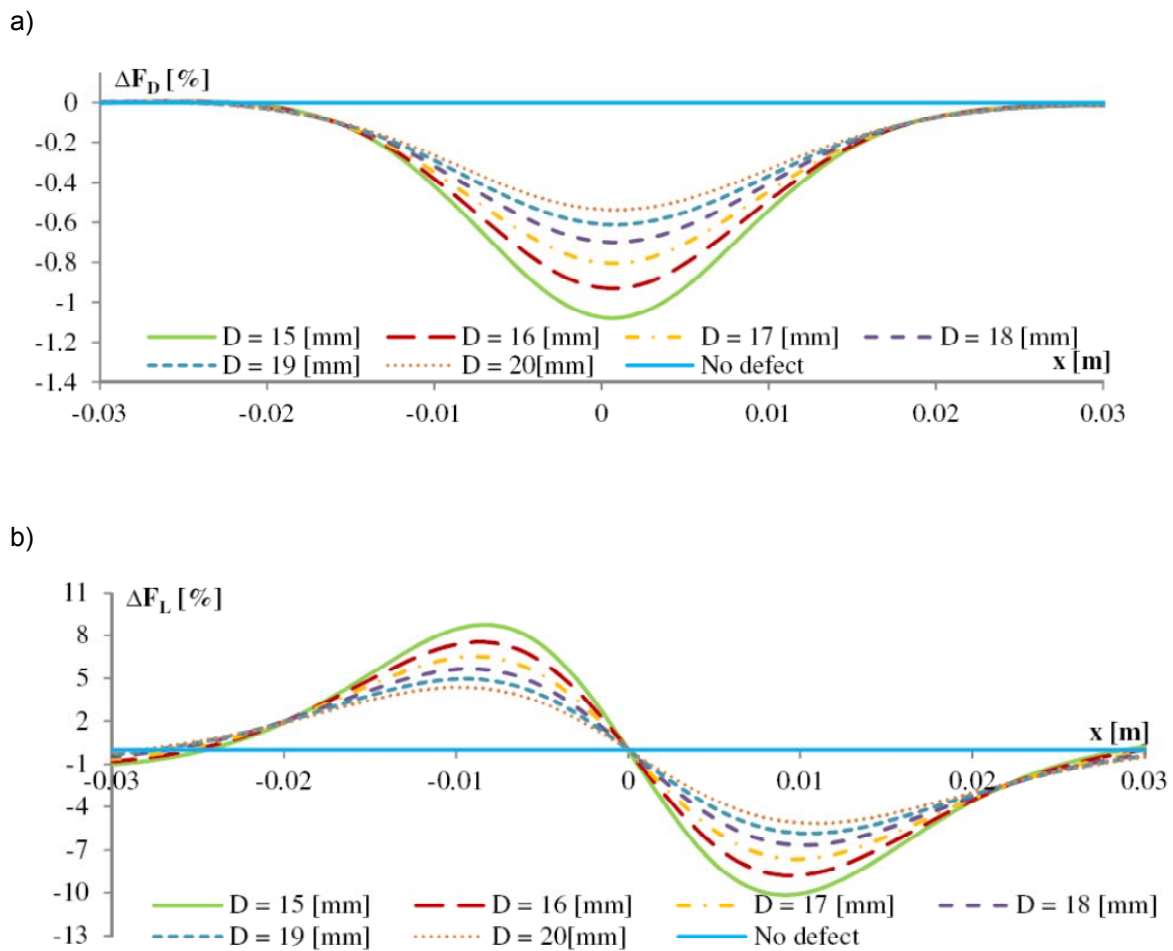



From this 2D analysis it is observed that the presence of the defect (square shaped defect with  $a = 5$  mm) is identified for depths of more than 20 mm from the material surface, corresponding to the given accuracy of the force sensor (Fig. 5). At this low magnetic Reynolds number ( $R_m = 0.0641$ ), the drag force is linearly proportional to the electrical conductivity and the lift force increases as a square of conductivity ( $R_m = \sigma\mu\nu H / 2$ ). This results in a higher force perturbation in the lift LF force component compared to the drag component (Fig. 5b). Therefore, it is possible to use the lift force component for the identification of very deep material defects. However, the exact depth threshold for the prescribed defect size is yet to be quantified.

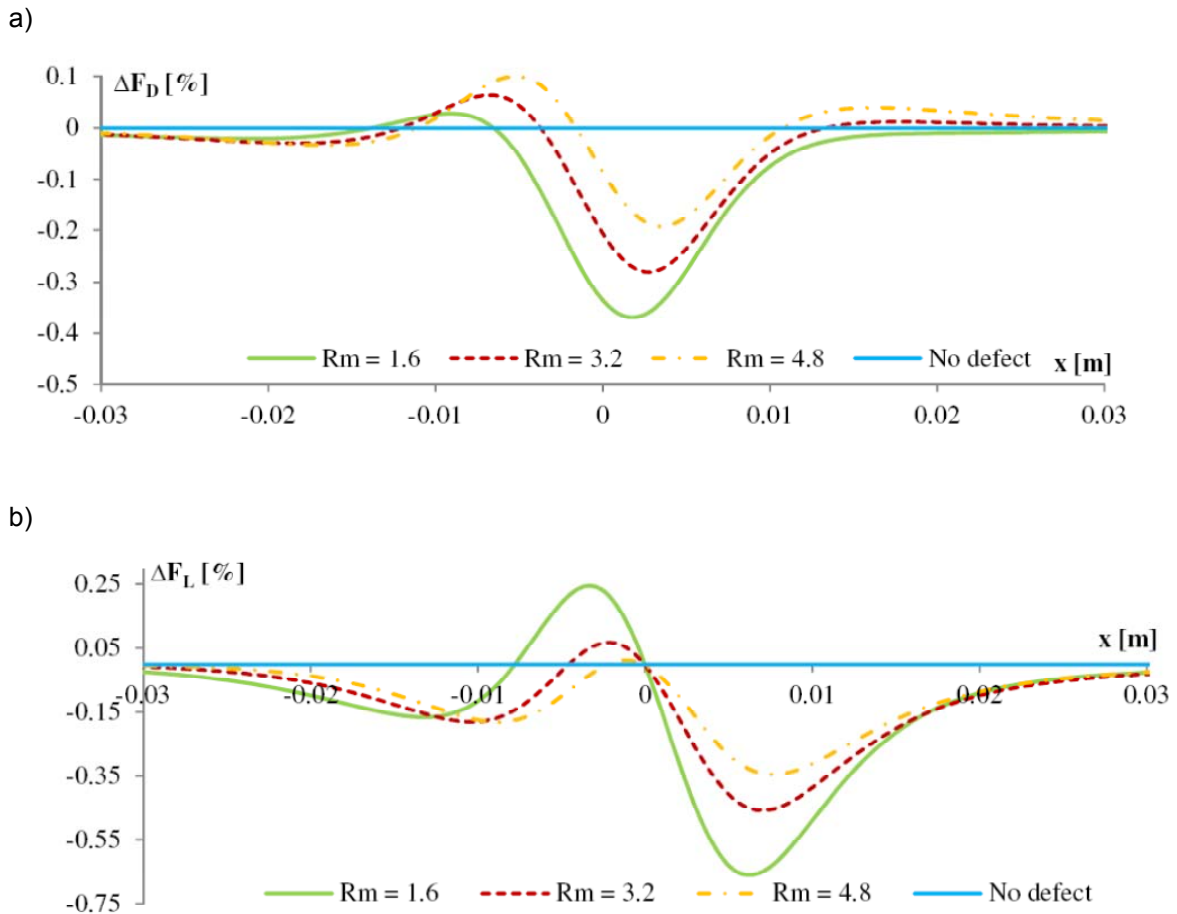
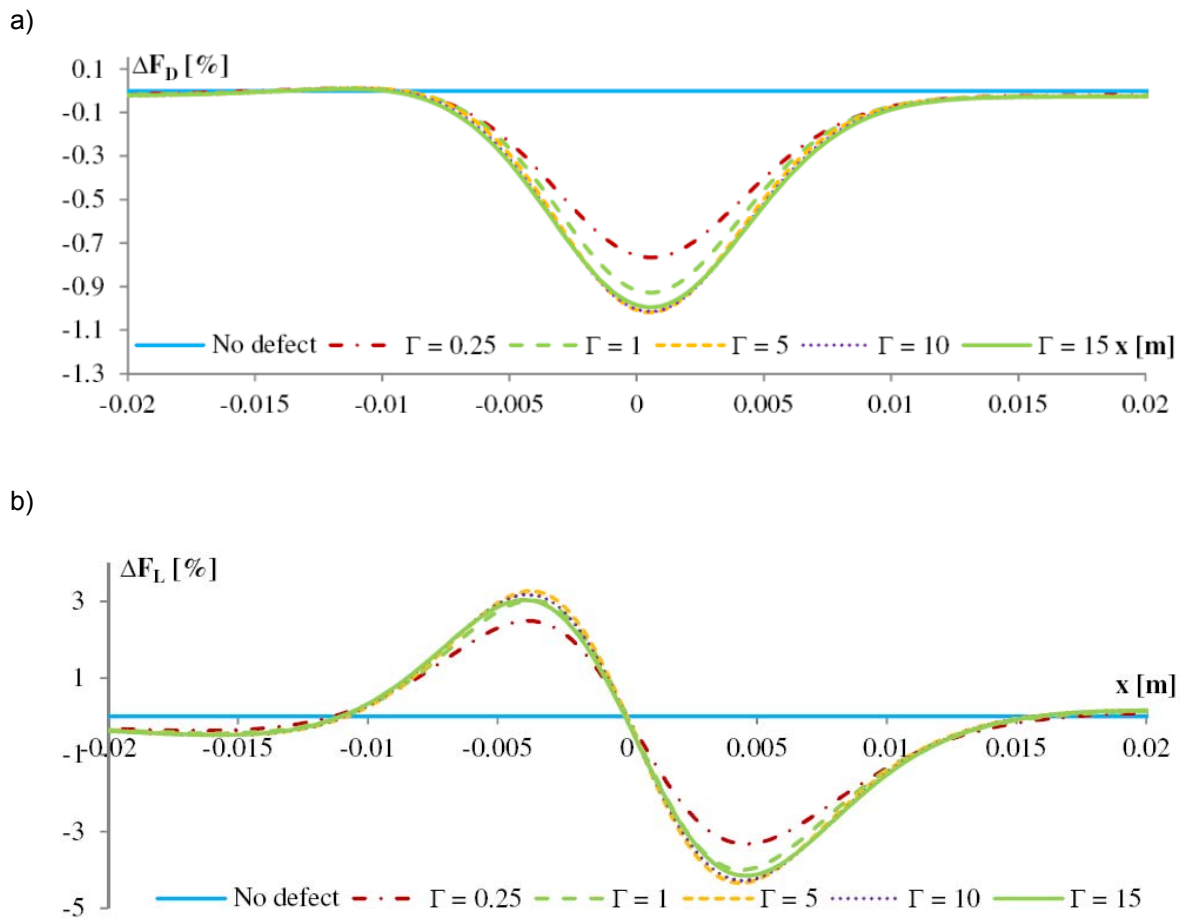

**Fig. 6. Linear LET LF perturbation due to a square defect ( $a = 1$  [mm]) for various  $R_m$ :**  
a) Drag component LF perturbation in [%] for  $D = 5$  [mm], b) Lift component LF perturbation in [%] for  $D = 5$  [mm]

For a higher magnetic Reynolds number, due to the skin effect, the eddy currents distribution is concentrated closer to the surface of the material. This

effect restricts the testing depth and possible identification of small defects (Fig. 6, 7). Moreover, it must be emphasised that the lift component of LF no longer increases quadratically with  $R_m$  [4].

To investigate the effect of the defect shape on the LF perturbation, 2D numerical simulations are performed for various defect aspect ratios ( $\Gamma = W_c / H_c$ ).



**Fig. 7. Linear LET LF perturbation due to rectangular defect ( $W_c / H_c$ ). Testing velocity ( $R_m = 0.32$ ): a) Drag component LF perturbation in [%] for  $D = 5$  [mm], b) Lift component LF perturbation in [%] for  $D = 5$  [mm]**

The surface area of the defect is kept constant and equal to  $2 \text{ mm}^2$  as well as the distance from the material surface ( $D = 5 \text{ mm}$ ). For a very thin and long defect ( $\Gamma < 1$ ), the reduced LF perturbation is observed. This is, as expected, since the intensity of the magnetic field and the induced eddy currents decrease deeper inside the material. When the defect is wide and shallow ( $\Gamma > 1$ ) the

obtained LF profiles show similar dependency. Further investigation involving complex shaped defects for specific applications has to be performed. This task is the subject of the author's ongoing work.

## 5. REMARKS AND CONCLUSION

---

Both the approaches, logical expressions and moving mesh, were successfully used to solve the presented linear LET problem. The logical expression approach, for the similar number DoF, was able to solve the given problem approximately 8 times faster than the moving mesh approach. Further reduction of the computational time was obtained by coupling the QS and TR formulation during the initialization. The presented two-dimensional parametric study showed that the LET represents a promising non-contact and non-destructive testing technique used in order to detect deep lying defects. Nevertheless, in order to develop LET systems for specific applications it is necessary to solve the full three-dimensional time-dependent electromagnetic field problem and to compute the Lorentz force acting upon the magnet system as a function of time for complex shaped defects. The considerable reduction of computational time makes LE the favourable approach to be used for future LET investigations.

## LITERATURE

1. Davidson P.A.: An Introduction to Magnetohydrodynamics, Cambridge University Press, Cambridge, England.
2. Thess A., Votyakov E.V., Kolesnikov Y.: Lorentz Force Velocimetry, Physical Review Letters, Vol. 96, 2006.
3. Ziolkowski M., Brauer H.: Fast Computation Technique of Forces Acting on Moving Permanent Magnet, Proceedings of the 17<sup>th</sup> Conference on the Computation of Electromagnetic Fields, Brazil COMPUMAG, 2009.
4. Van Bladel J., De Zutter D.: Magnetic Levitation: The Track Currents, Appl. Phys. B 34.
5. Uhlig R.P., Zec M., Ziolkowski M., Brauer H.: Lorentz Force Eddy Current Testing: Modelling of Permanent Magnets Using Logical Expressions for Dynamic Electro-Magnetic Simulation Involving Moving Structures, CEM 2011, proceedings, pp. 196-197.
6. Brauer H., Ziolkowski M.: Eddy Current Testing of Metallic Sheets with Defects Using Force Measurements, Serbian Journal of Electrical Engineering, vol. 5, No. 1, 2008, pp. 11-20.
7. Comsol Multiphysics, User Guide, <http://www.comsol.com>.
8. ALTHEN Mess- und Sensortechnik, <http://www.althen.de>.

TESTOWANIE WIROPRAĐOWE  
W OPARCIU O POMIAR SIŁY LORENTZA:  
DWUWYMIAROWE STUDIUM NUMERYCZNE

Mladen ZEC, Robert P. UHLIG,  
Marek ZIOLKOWSKI, Hartmut BRAUER

**STRESZCZENIE** *Testowanie z wykorzystaniem prądów wirowych i pomiarów siły Lorentza jest bezstykową i nieniszczącą metodą służącą do detekcji głębokich defektów w materiałach stałych przewodzących. Zasada tej metody jest oparta na pomiarze siły Lorentza wytwarzanej w wyniku wzajemnego ruchu między magnesem trwałym i badanym materiałem. Gdy magnes jest przesuwany ponad defektem, to siła Lorentza działająca na magnes ulega chwilowym zmianom. Detekcja tych perturbacji siły Lorentza pozwala identyfikować i lokalizować defekty w materiale.*

*Głównym celem niniejszej pracy jest dostarczenie dwuwymiarowych danych numerycznych dla ruchu magnesu trwałego w sąsiedztwie ciała stałostanowego. Analiza jest przeprowadzona dla tzw. liniowego problemu testowania wiroprowadowego, biorącego pod uwagę liniowy ruch magnesu trwałego nad prętem w stanie stałym. Metodę elementów skończonych opartą na handlowym solverze COMSOL Multiphysics użyto do symulowania rzeczywistej geometrii danego problemu z odpowiednimi równaniami różniczkowymi. Cele tej pracy obejmują ocenę indukowanych prądów wirowych, rozkład ogólnych i lokalnych sił Lorentza w ciele stałym z uwzględnieniem predefiniowanych defektów. Obydwa podejścia: wyrazów logicznych i ruchomej siatki użyto z powodzeniem, z tym, że to pierwsze pozwalało rozwiązać dany problem 8 razy szybciej.*